

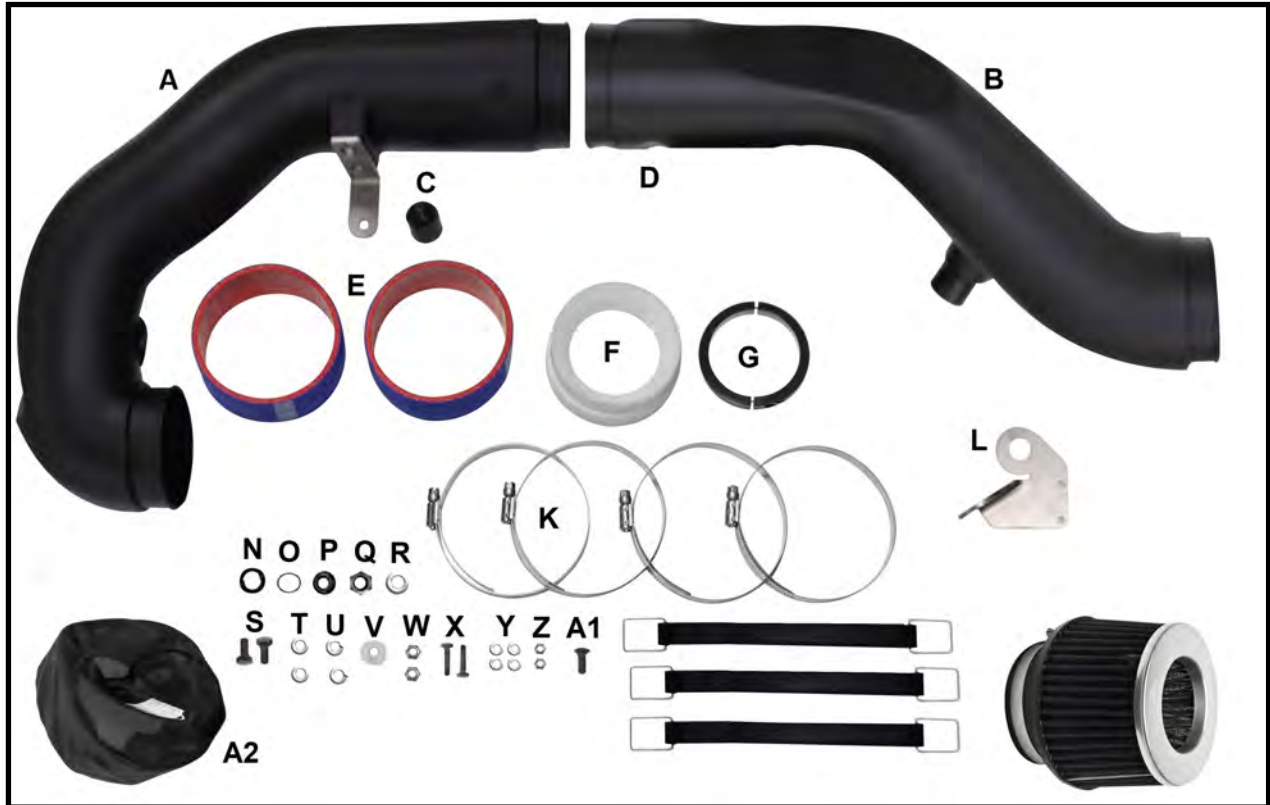

Sea-Doo 2016-17 RXT/GTX 300 & All RXP 300 Power Filter Kit

PART# - RS13140-3



Applications:

Sea-Doo 2016-17 RXT/GTX 300 & All RXP 300

Approximate Installation Time:

1.7 Hrs.

Recommended Specialty Tools:

None

Part #

N/A

Required Materials:

Blue Loctite

Part #

N/A

Required Add-on Options:

Catch Can/Engine Breather Kit

— OR —

Power Filter Breather Hose

Part #

RS19050-BCC-5

RS19050-PFBH



Sea-Doo 2016-17 RXT/GTX 300 & All RXP 300 Power Filter Kit

PART# - RS13140-3

COMPONENT LIST

<u>Description</u>	<u>RIVA Part #</u>	<u>Qty. Req.</u>	<u>Comments</u>
A Tube A	RTL-RS13140	1	
B Tube B			
Loard Mount, Lg	RY15-2NPF2	1	Assembled to tube B
Nylon Flat Washer, M8	95610A580	1	Assembled to Lg Loard Mount
C Loard Mount, Sm	9232K17	1	
D Regulator Bracket	RS13050-RB	1	
E Silicone Coupler, (4" ID x 2-1/8" L)	RY15-04/2.0	2	
F Velocity Stack	QCA-RS13140	1	
G Threaded Ring			includes 6-32 screws (2)
K Hose Clamp, (#64)	6564E-52	4	
L Lift Bracket			
N Sensor Mount Collar	QCA-RS13140-SRB	1	Waterbox Temp Sensor Relocation Bung Kit
O Sensor Mount O Ring			Waterbox Temp Sensor Relocation Bung Kit
P Sensor Mount			Waterbox Temp Sensor Relocation Bung Kit
Q Plug			Waterbox Temp Sensor Relocation Bung Kit
R Sealing Washer			Waterbox Temp Sensor Relocation Bung Kit
S Bolt, M8 X 16, SHCS	830236SS	2	
T Washer, Flat M8	369023SS	3	
U Washer, Lock M8	04478	2	
V Washer, Fender M8	410.8.24	1	
W Nylock Nut, M8	LMNL5X00800	2	
X Bolt, 6MM X 25MM HHCS	830158SS	2	
Y Flat Washer, (6mm)	369021SS	4	
Z Nylock Nut, (6mm)	561030SS	2	
A1 Bolt, (8mm x 20mm), BHCS	098.8.20	1	
A2 Pre-Filter, (Black, W/ Riva Logo)	RK13090PF-BK	1	
A3 Strap, RR EPDM + SS Hook	2938500874	3	
A4 Air Filter	RK13090-2	1	Includes clamp
A5 L Bracket	FSM-RS13140-B	1	
A6 Bolt, 6MM X 16MM HHCS	LMHC3X06016	2	
A7 Washer, Lock M6	LMLW7X00600	2	

We strongly recommend the use of a service manual to familiarize yourself with the various components and procedures involved with this installation. Please note that some of the original hardware removed in the disassembly process will be used in the installation process. These instructions have been written in step-by-step format and refer to illustrations. Read through instructions entirely before performing installation. Please follow these step-by-step instructions and illustrations carefully.

***** ALLOW ENGINE TO COOL COMPLETELY BEFORE PERFORMING INSTALLATION *****

***** NO SMOKING *** NO SMOKING *** NO SMOKING *****

- INSTALLATION INSTRUCTIONS -

Open front compartment.

RXT/GTX 300

Remove storage bin. Remove three rivets and remove compartment door. (Figure 1)

Figure 1



Pull out on the tabs to release the vent tubes and pull vent tubes down and out of the hull. (Figure 2)

Figure 2



RXP-X

Open storage compartment and remove cover (2 bolts)

Remove plastic rivets (A) and disconnect retaining strap (B). Remove divider from storage compartment. (Figure 3)

Figure 3

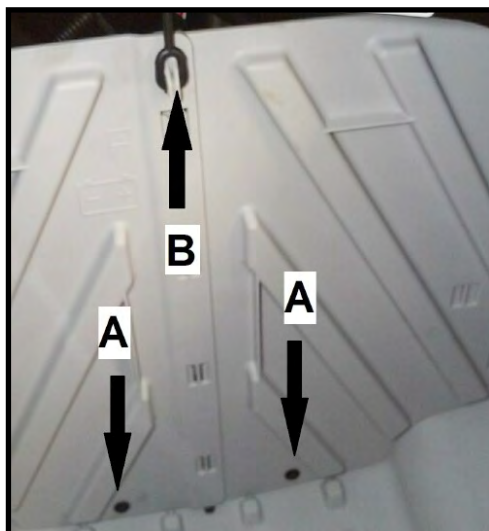

Remove darts (A) and remove vent hoses from hull. (Figure 4)

Figure 4

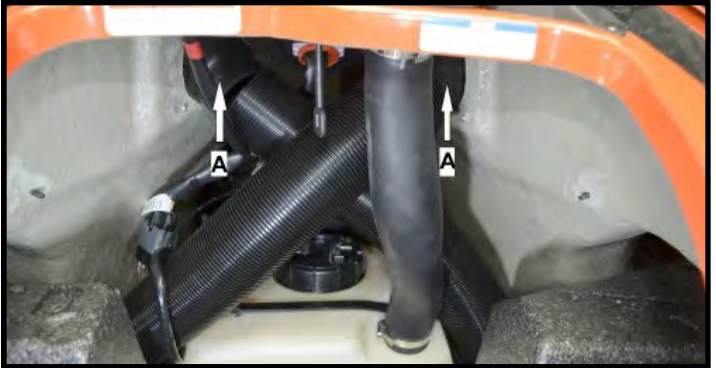

Loosen clamp (A) and remove fuel filler hose from tank.

Unclip fuel line (B) from fuel pump module.

Unscrew nut (C) and remove fuel module. (Figure 5)

Note: Take care not to drop gasket into tank. Gasket may be swollen. Place in freezer to return to original size before reinstalling.

Figure 5

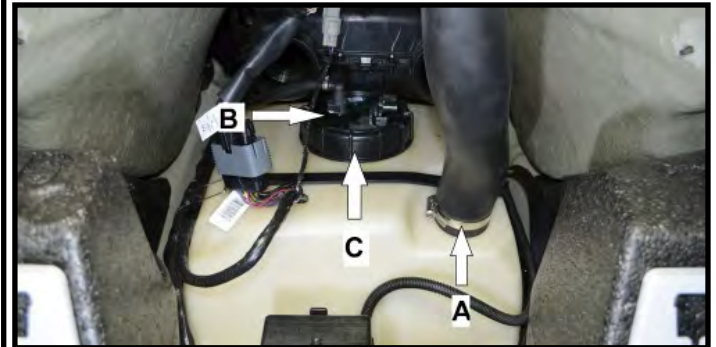

All Models

Disconnect OTAS (A) and Gauge (B) connectors. Cut 2 zip ties (C) securing fuel hose and wire harness to air box. Release 2 rubber hold down straps (D). (Figure 6)

Figure 6

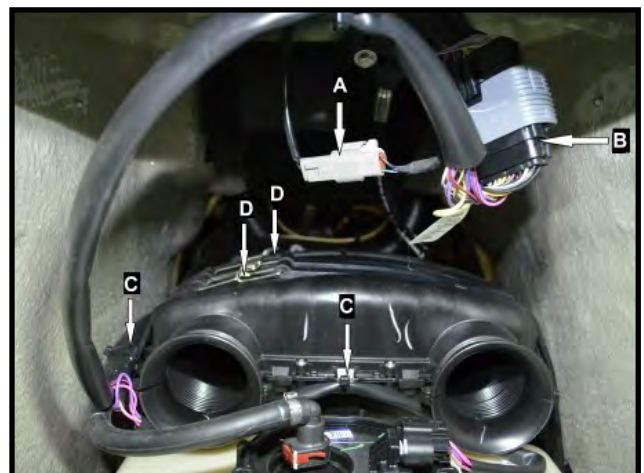

Open (RXT/GTX) or remove (RXP) seat.

RXT/GTX

Remove plastic darts securing vent hoses to air inlets and pull vent hoses down off inlets. (Figure 7) Remove vent hoses from craft and cut to 18" overall length.

Note: Remove excess from bottom end of hose or you will have to make new holes for the darts when re-installing hoses.

Figure 7



All Models

Cut zip tie (A) securing wire harness and fuel line to airbox rear. Release rubber strap (B) securing rear of airbox. (Figure 8)

Figure 8



Release clamp (A) holding OEM inlet tube to airbox hose. Cut zip tie (B) securing wire harness to OEM inlet tube. (Figure 9)

Figure 9

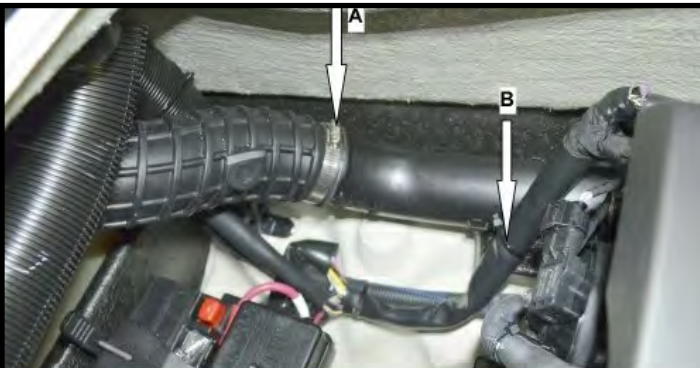

2018 + RXP-X ONLY

Remove bolts (2) holding voltage regulator / rectifier on rear of airbox. Drop regulator into hull.

RXP-X

Working from front storage compartment pull airbox out of front of ski and discard. Airbox has to move upward to clear fuel tank. If the top of the airbox gets stuck, grasp inlet tubes and push downward while pulling firmly out. The top of the fuel tank will depress enough to allow the airbox to be removed.

RXT/GTX

Remove airbox from rear of fuel tank compartment into engine compartment.

All Models

Remove 3 OEM starboard (right side) fuel tank hold down straps previously disconnected. Replace with shorter supplied straps. Reconnect to secure tank. **Tip: Spray window cleaner on underside of straps and top of fuel tank to make stretching straps over tank easier.**

RXP-X

Reinstall fuel pump module and gasket, connect fuel line and fuel filler hose. If gasket is damaged or does not fit replace with OEM part no. 293250173.

RXT/GTX

Reinstall shortened vent hoses on air inlets, re-using OEM darts. Do not cross vent hoses. Route hoses straight down along side of hull.

All Models

Release clamp (A) securing supercharger inlet hose to rear of OEM inlet tube. Pull hose off inlet tube. Remove OEM inlet tube by sliding out through front storage compartment. Release clamps (B, C and D) and remove OEM supercharger inlet hose and crankcase breather hose. Disconnect cable from exhaust temp sensor (E) and drop connector into hull. (Figure 10)

Figure 10

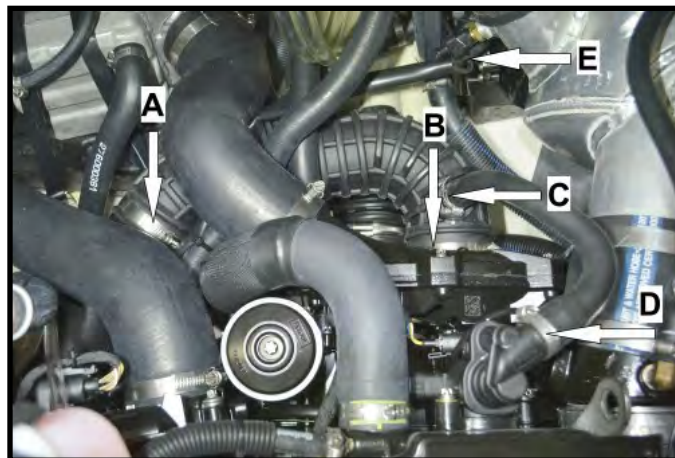

Sea-Doo changed the location of the temperature sensor in the waterbox during production of 2016 model 300s. (Figure EX1).

Figure EX1

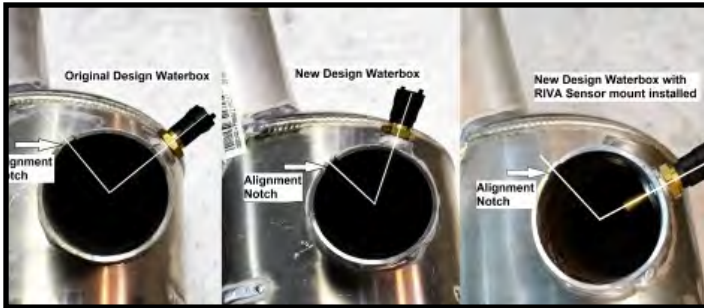

Note that the location of the temperature sensor is changed in relation to the index notch on the waterbox outlet. The new location of the temperature sensor interferes with Inlet Tube A of this kit. **If your ski is equipped with one of these waterboxes the sensor must be re-located to install this kit.**

Disconnect waterlines between exhaust manifold and stock water box (A) Disconnect engine breather hose from TOPS valve at rear of cylinder head (C). Disconnect exhaust outlet hose from water box (D). Remove rubber strap around waterbox (E). (Figure EX2)

Figure EX2

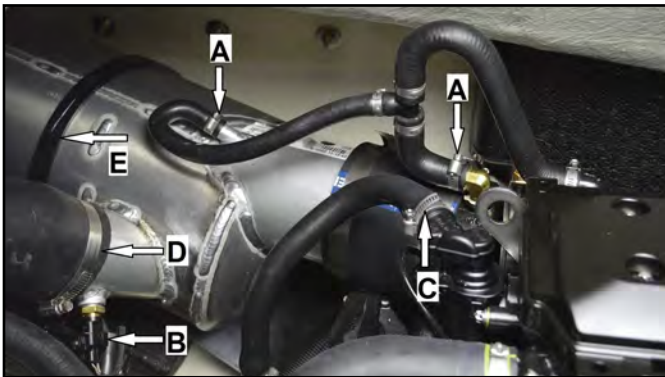

At exhaust clamp loosen t-bolt nut enough to allow end ('T') to be removed from band clamp. Remove exhaust clamp. (Figure EX3)

Figure EX3

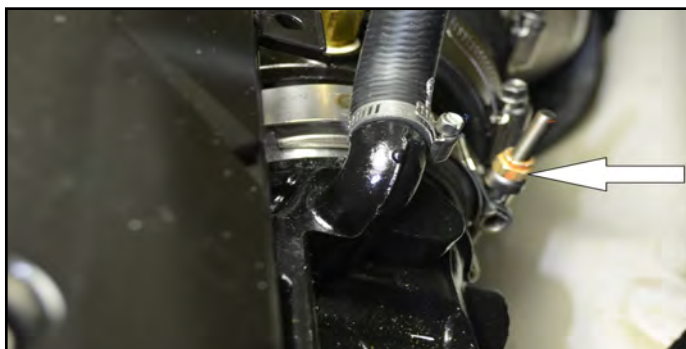

Remove water box assembly from hull.

Remove temperature sensor from water box. Install supplied plug into OEM temperature sensor hole. **NOTE: Apply red Loc-tite to threads. Do not over tighten.**

Place supplied Sensor Mount Collar onto waterbox outlet tube, curved side down. Position collar next to weld. **Make sure collar is not on weld bead!** Trace inside opening of collar with a marker. (Figure EX4)

Figure EX4



Measure and mark the center of the hole (Figure EX5)

Figure EX5



Hole center should be at 3:00 to 4:00 position with respect to index notch in waterbox tube. (see figure EX1)

Center punch and drill hole center with a 1/4" drill bit. Enlarge hole to full size using a 5/8" drill bit.

Press supplied o-ring into groove in curved side of Sensor Mount Collar. Insert supplied Sensor Mount through hole from inside of pipe. Slip collar over mount. Install temperature sensor into Sensor Mount and tighten. **Apply red Loc-tite to threads. Do not over tighten.** (Figure EX6)

Figure EX6



Reinstall waterbox and coupler assembly onto exhaust manifold reversing removal procedure. **NOTE: Do not tighten hose clamp yet. Tip: Lubricate inside of coupler and outside of exhaust manifold with glass cleaner to ease installation.**

Leave waterbox loose and exhaust outlet disconnected to make it easier to install Power Filter Inlet Tube A.

Important: If you are using the RIVA Breather Catch Can/ Engine Breather Kit (RS19050-BCC-5) install it now using the instructions supplied with that kit.

If you are using the RIVA Power Filter Breather Hose (RS19050-PFBH) follow the installation steps below.

Using a Dremmel, Roto Zip or similar tool, make a 7/8" diameter hole in the center of the boss provided on the supplied inlet tube A. Place the supplied o-ring on the supplied 7/8" barbed fitting and insert it through the hole from the inside of the inlet tube. Secure with supplied 7/8" nut. **Note: Apply silicone sealer to threads.** (Figure 11)

Figure 11



Remove OEM front engine lifting eye and replace with supplied mount bracket / lift eye as shown. Reuse OEM 6mm torx head screws. (Figure 12)

Figure 12



Loosen bolts in supplied threaded ring and slip over supercharger inlet. Note: Assemble ring so that both ring halves have two dots showing. (This will align threads in both halves.) Position threaded ring against flare on su-

percharger inlet and tighten allen screws. **Do not over tighten screws. Do not use Loctite on threads.** (Figure 13)

Figure 13



Screw velocity stack onto threaded ring. Tighten hand tight. Be sure velocity stack is seated all the way onto threaded ring. (Figure 14)

Figure 14



Slip supplied 2" silicone coupler onto velocity stack. Slide two supplied hose clamps loosely over silicone coupler. Tighten clamp closest to engine only. (Figure 15) **Tip: Spray glass cleaner on inside of coupler and outside of Velocity Stack to ease installation.**

Figure 15

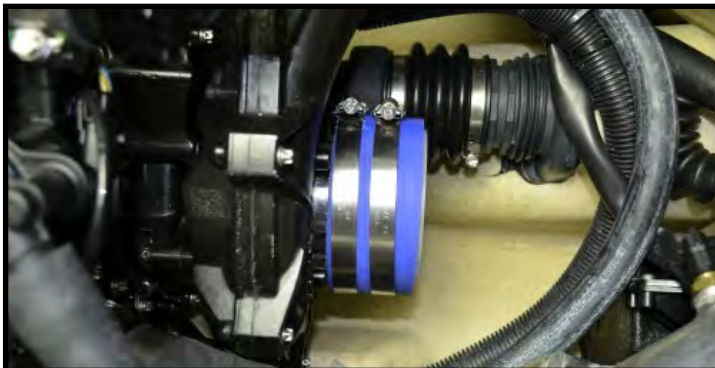

Loosely install supplied stainless steel support bracket onto 'Tube A' as illustrated below using 2 each of the supplied M6 hex cap bolts and M6 lock washers (Figure 16).

Figure 16



Center bracket evenly side-to-side on mounting point. Once bracket is properly aligned tighten bolts (Figure 17). **NOTE: Do not overtighten bolts.**

Figure 17

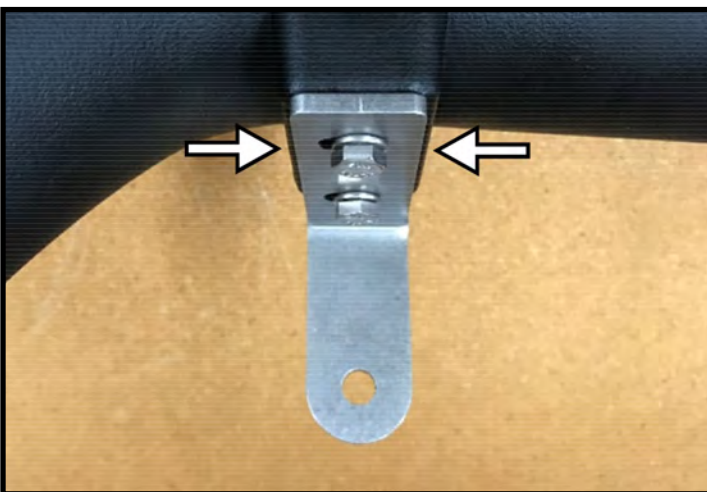

NOTE: Bracket is slotted to accommodate superchargers with spacer plates.

Install Inlet Tube A onto velocity stack. Velocity Stack must slide into Inlet Tube until it is completely seated. When inlet tube is properly installed lord mount on L bracket will align with the hole in rear engine lift eye. Install 8 mm nyloc nut and fender washer onto lord mount stud. Do not tighten.

Align exhaust pipe with exhaust manifold. Note measurements in instruction illustrations. Alignment is critical to

prevent exhaust leaks. (Figure 18) Tighten clamp.

Figure 18

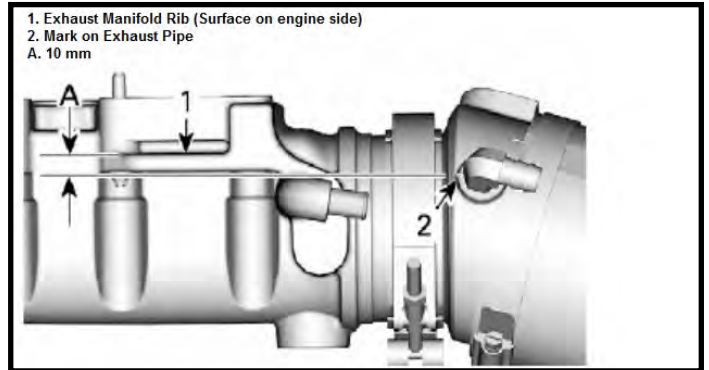

Reconnect waterlines previously removed. (Figure EX2) Pull loose hose clamp onto coupler over Inlet Tube and tighten. (Figure 19) **Do not over tighten clamps.**

Tip: Lubricate coupler and tube with glass cleaner.

Figure 19

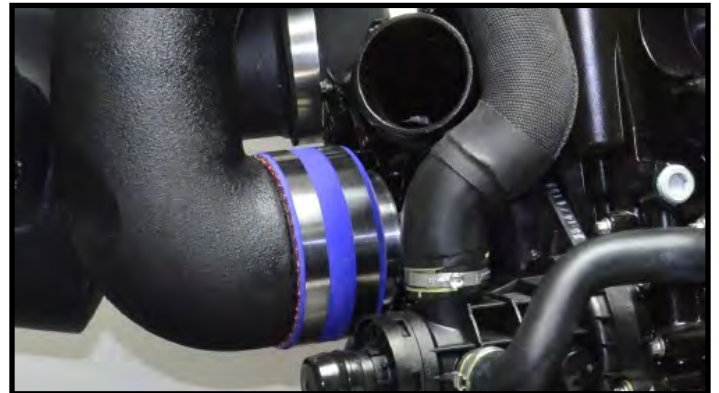

Reattach cable to exhaust temperature sensor. If using OEM breather system install formed hose onto crankcase vent valve and barbed fitting previously installed into Inlet Tube A. Short end of formed hose goes onto barbed fitting.

Reinstall exhaust outlet tube/hose.

Install Flame Arrestor and Pre-filter onto Inlet Tube B using supplied hose clamp. Install supplied 2.5" silicone coupler onto Inlet tube B. Slide supplied hose clamps onto inlet tube B but do not tighten. (Figure 20) **Tip: Lubricate Flame Arrestor, coupler, and tube with glass cleaner to ease installation.**

Figure 20



2018 + RXP-X ONLY

Install voltage regulator / rectifier onto bracket using supplied 6 x 25mm HHCS (2), 6mm flat washers (4) and nyloc nuts (2) as shown. (Figure 21)



Figure 21

Using an 11/32" bit drill a hole in the center (left to right) of the deck under the front seat catch. Hold the drill as straight up and down as possible. (Figure 20)



Figure 22

Using supplied 8x20 BHCS(1), 8mm Flat Washers (2) and 8mm nyloc Nut (1) secure regulator bracket to underside of deck.

ALL Models

Insert filter end of assembled Inlet Tube B into starboard side of hull ahead of engine and rotate assembly until inlet tubes A and B are aligned. Pull Inlet Tube B back toward Tube A until the ends of the tubes meet and the coupler is fully installed.. Secure Inlet Tube B to front engine lift eye/ bracket with supplied 8 mm bolt, flat and lock washers. **Note: Apply Blue Loctite to threads.**

Align arrows on inlet tubes (Figure 23) and tighten fasteners on the lord mounts on Inlet Tubes A and B. Verify that Inlet tube does not touch oil filler cap or crankcase breather.

Figure 23

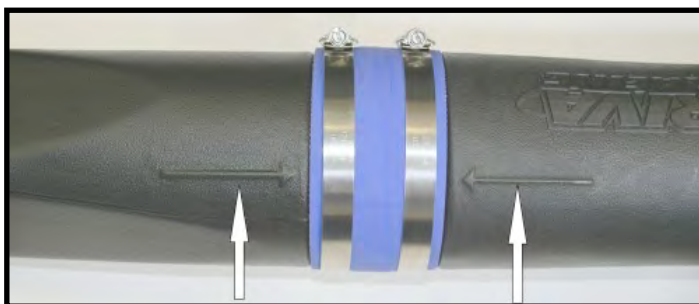

While maintaining alignment tighten hose clamps on coupler between A and B. **Do not over tighten clamps.**

Replace parts removed from front compartment to access OEM airbox.

Check bilge for tools, rags, etc. Run craft on a flush kit to check for proper operation.

Remember, the water belongs to everyone.

Please ride responsibly and respect the environment!

Technical Support

For answers to questions regarding installation or trouble shooting RIVA Performance Products contact:

RIVA Technical Support directly at (954) 247-0705 or by e-mail at tech_support@rivaracing.com.

Limited Warranty

RIVA Power Filter Kits carry a 90-day limited warranty to the original purchaser. They are warranted to be free of defects in materials and workmanship under normal use and service. Customer modified components will be void of warranty. This warranty is limited to defects in the primary components only. Finish and/or wear marks in or on primary components are not covered under this warranty.

RIVA Racing's liability is expressly limited to the repair or replacement of the components contained within or associated with this kit. RIVA Racing agrees to repair or at RIVA's option, replace any defective unit without charge, if product is returned to RIVA Racing freight prepaid within the warranty period. Any equipment returned which, in RIVA's opinion, has been subjected to misuse, abuse, overheating or accident shall not be covered by this warranty.

RIVA Racing shall have no liability for special, incidental or consequential damages or injury to persons or property from any cause arising from the sale, installation or use of this product.

No other warranty, express or implied, including, but not limited to the implied warranties of merchantability and fitness for a particular purpose, applies. Various states do not allow for the limitation of incidental or consequential damages and therefore the above exclusion or limitation may not apply to you.

Warranty does not include the expenses related to freight or transportation of parts or compensation for any inconvenience or loss of use while being repaired. A copy of the original invoice and a Return Authorization Number (RA#) must accompany all warranty claims.

Warranted replacement parts will be returned freight collect.